

The Valtra logo is presented in a white, bold, sans-serif font with a thin black outline. It is centered within a red trapezoidal shape that is tilted slightly to the right. The background of the entire page is a solid, bright yellow.

Manual dos Rótulos Valtra

Sumário

Tipografia	04
Paleta de Cor	06
Ilustrações	07
Desenhos	
Cores	
Racional de Diagramação	09

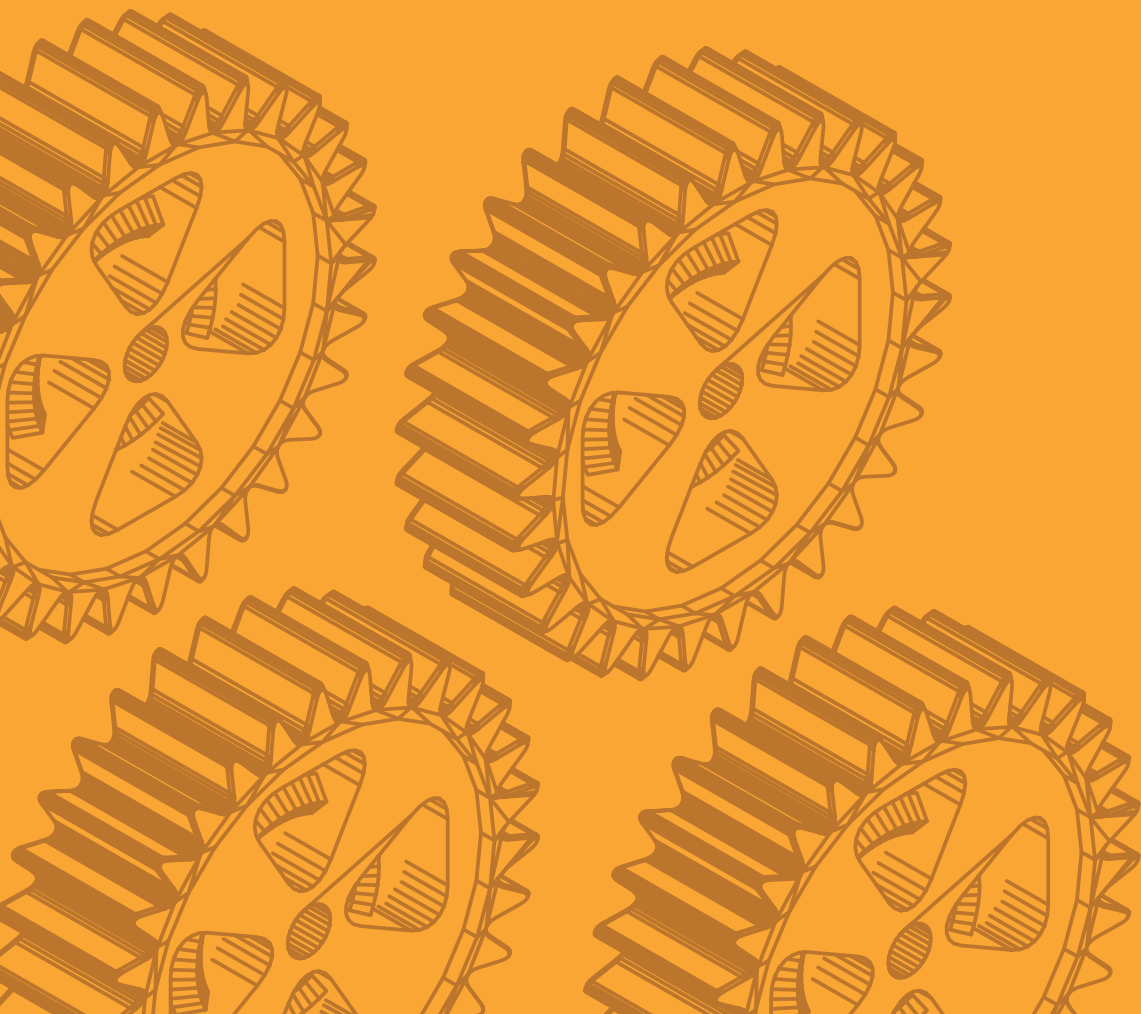

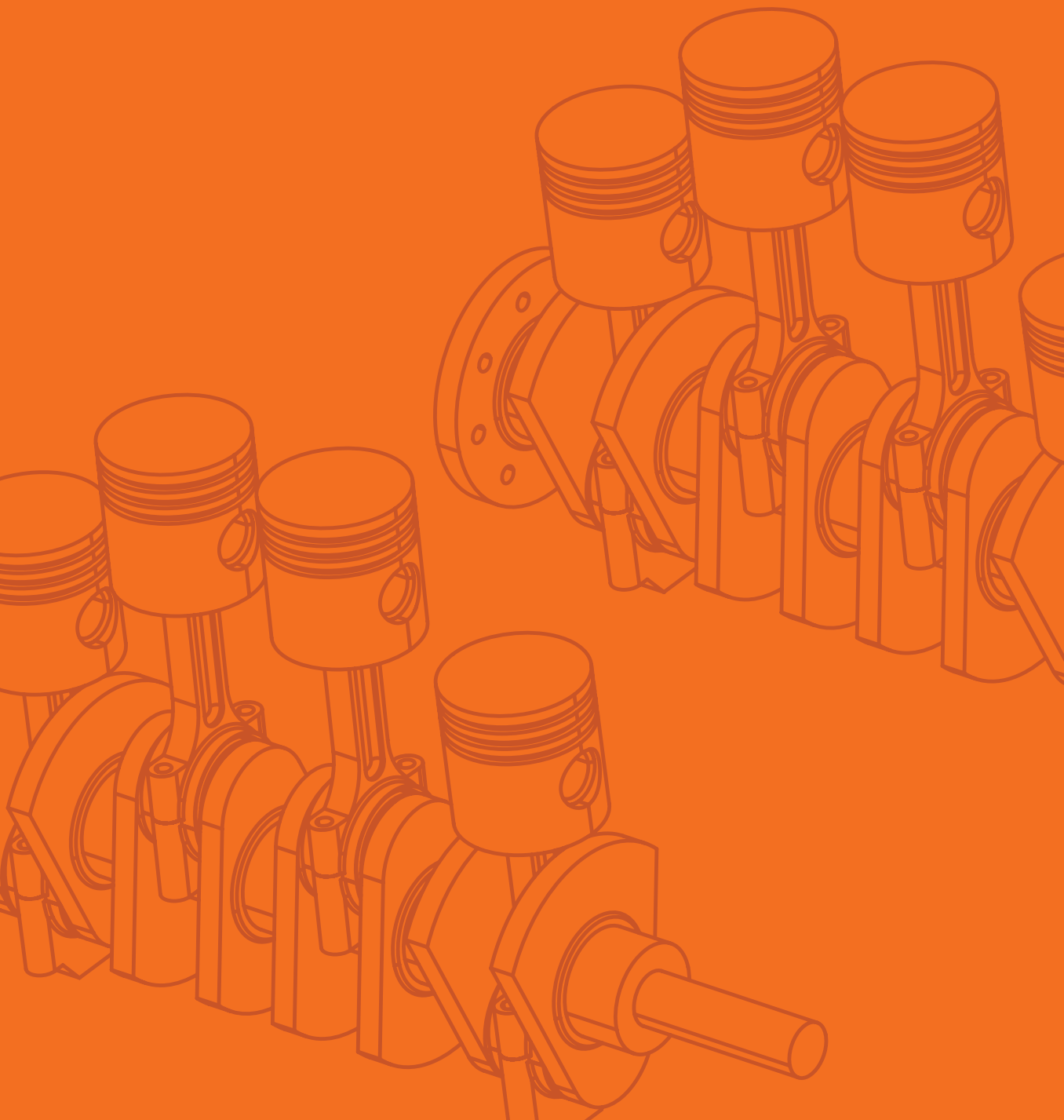

Manual dos Rótulos Valtra

Este manual apresenta as diretrizes para a construção dos rótulos Valtra, que devem ser seguidas para garantir a fidelidade na reprodução. Certifique-se de que os arquivos utilizados são originais.

Paleta Principal

A tipografia principal utilizada para o nome do produto é a Campton, criada no início do século XX. Ela foi uma das primeiras fontes sem serifa a ser criada e apresenta um desenho incomum, moderno e inovador.

Campton

Thin

Thin Italic

Extralight

Extralight Italic

Light

Light Italic

Book

Book Italic

Medium

Medium Italic

SemiBold

SemiBold Italic

Bold

Bold Italic

ExtraBold

ExtraBold Italic

Black

Black Italic

Tipografia de Apoio

A tipografia utilizada nos textos informativos (de apoio) dos rótulos Valtra é a Futura Condensed e Futura (T1), uma fonte também do início do século XX, que tem um desenho geométrico e tradicional.

A Futura já é utilizada na comunicação de Shell. Sendo assim, os rótulos conversam com os outros produtos da Marca.

Futura Condensed

Light

Light Oblique

Book

Book Oblique

Medium

Medium Oblique

Bold

Bold Oblique

Extra Bold

Extra Bold Oblique

Futura (T1)

Light

Light Oblique

Book

Book Oblique

Medium

Medium Oblique

Bold

Bold Oblique

Extra Bold

Extra Bold Oblique

Paleta de Cor

A Paleta de cor de Valtra foi inspirada nas cores que a Marca usa hoje em sua comunicação. Sendo assim, foram priorizados os tons terrosos nos rótulos.

As cores também servem para diferenciar e categorizar cada produto, que são divididos em: Engine, Transmission e Hydraulic.

Valtra Engine



Pantone 166 C
C0 M70 Y100 K0

Valtra Transmission



Pantone 7409 C
C0 M40 Y90 K0

Valtra Hydraulic



Pantone 7571 C
C20 M60 Y90 K0

Ilustrações

Desenhos

As ilustrações desenvolvidas para os rótulos de Valtra estão relacionadas a cada tipo de produto. Então, seus desenhos são representações da peça que cada tipo de óleo prioriza.

Valtra Engine

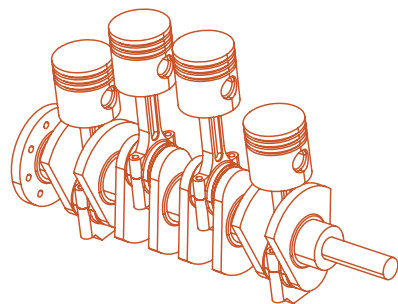

Valtra Engine Genuine CH-4/CH-I
Valtra Engine Premium CH-4/CH-I

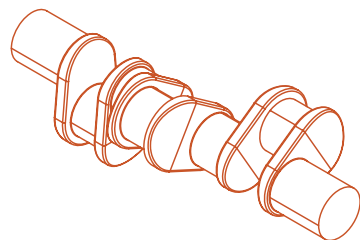

Valter Engine Ultra

Valtra Transmission

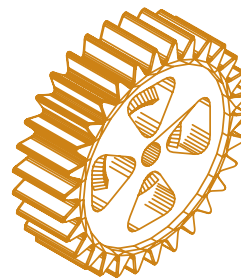

Valtra Transmisison Super
Valtra Transmisison Premium

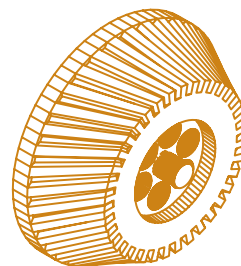

Valtra Transmisison Power

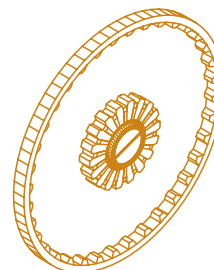

Valtra Transmisison Unique

Valtra Hydraulic

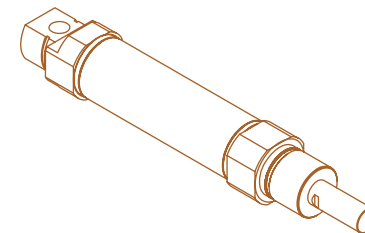

Valtra Hydraulic Max Plus 68

Ilustrações

Cores

As ilustrações acompanham a tonalidade da cor que está em vigor no rótulo. Sendo assim, as cores escolhidas foram sobretons das cores principais.

Valtra Engine

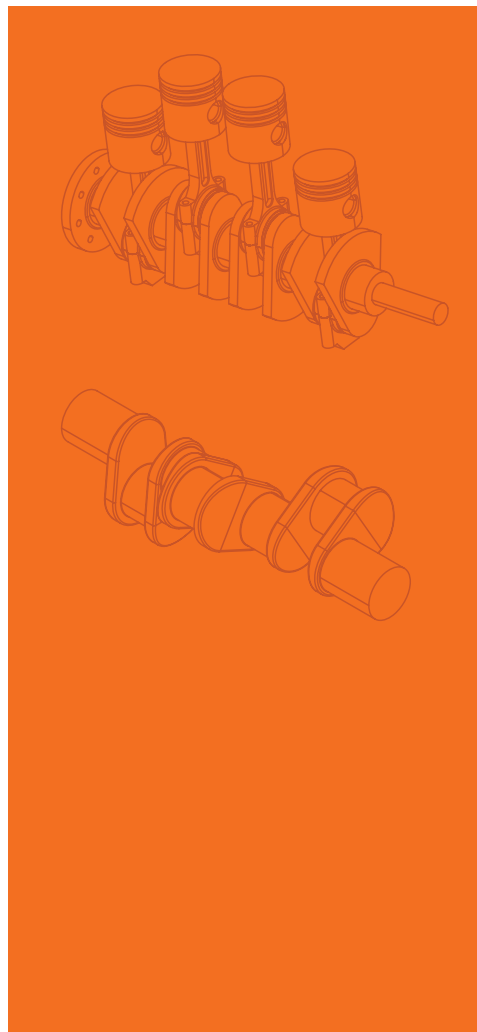

Pantone 159 C
C15 M80 Y100 K5

Valtra Transmission

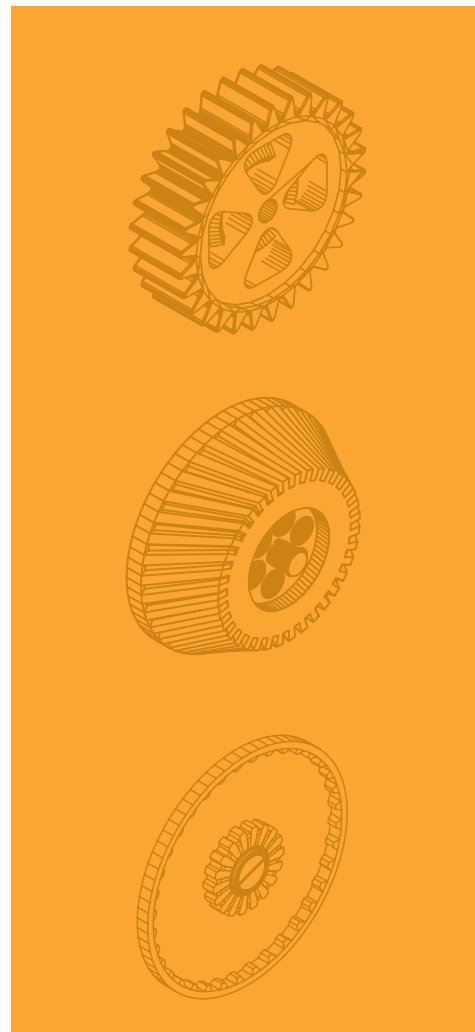

Pantone 7565 C
C0 M45 Y100 K20

Valtra Hydraulic

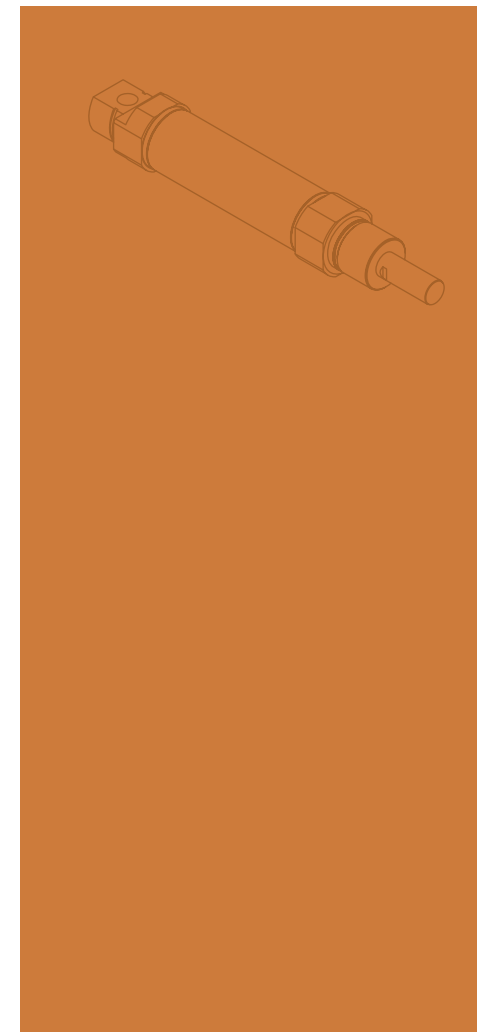

Pantone 7573 C
C25 M65 Y100 K0

Diagramação

Racional

Mainstream

No rótulo mainstream, a faixa presente na parte frontal do rótulo e o nome do produto ficam em branco.

Valtra Engine

Cores



Ilustrações

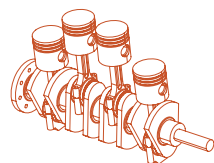

Rótulos



Valtra Transmission

Cores



Ilustrações



Rótulos



Valtra Hydraulic

Cores



Ilustrações

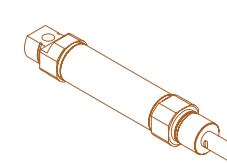

Rótulos



Premium

No rótulo premium, a faixa presente na parte frontal do rótulo e o nome do produto são aplicados com o Pantone 429 C o que cria a diferenciação entre as categorias.

Cores



Ilustrações

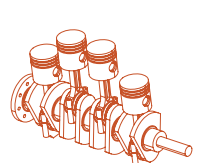

Rótulos

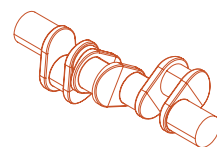

Cores



Ilustrações



Rótulos



