

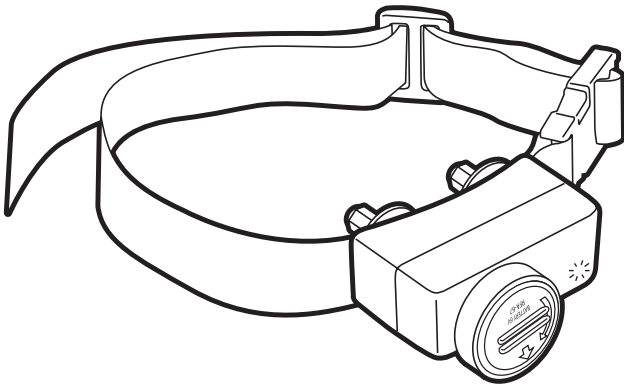

protect. **teach.** love.

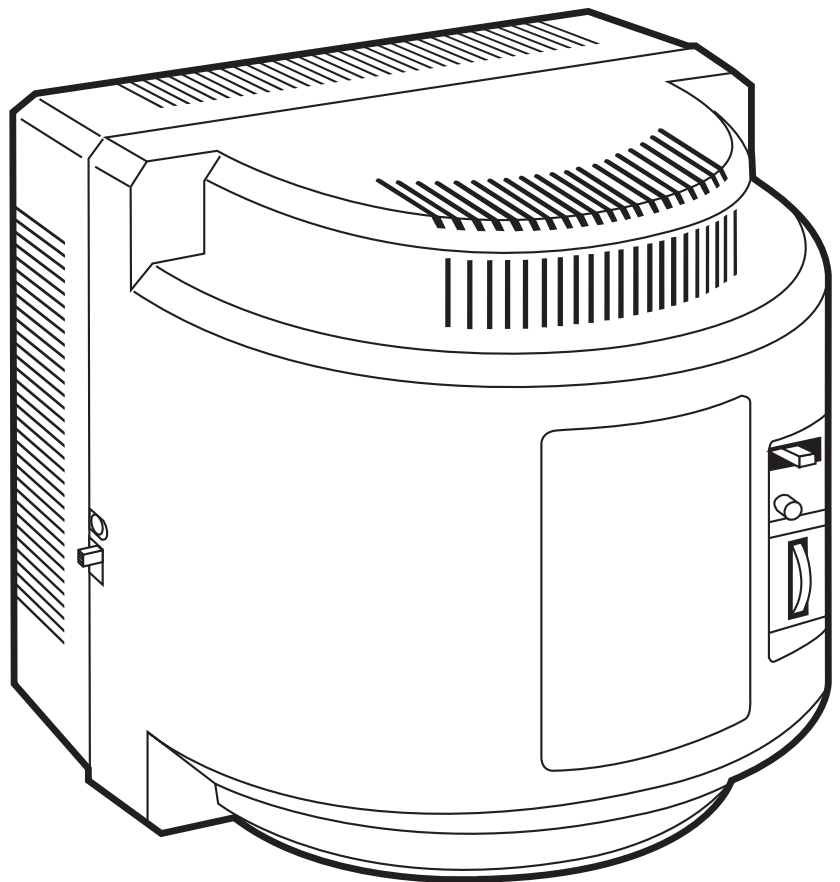

Model Number
PIF-300



wireless pet containment system™

operating and training guide

PLEASE READ THIS ENTIRE GUIDE BEFORE BEGINNING

Important Safety Information

Explanation of Attention Words and Symbols used in this guide



This is the safety alert symbol. It is used to alert you to potential personal injury hazards. Obey all safety messages that follow this symbol to avoid possible injury or death.

⚠ WARNING

WARNING indicates a hazardous situation which, if not avoided, could result in death or serious injury.

CAUTION

CAUTION, used without the safety alert symbol, indicates a hazardous situation which, if not avoided, could result in harm to your pet.

NOTICE

NOTICE is used to address safe use practices not related to personal injury.

⚠ WARNING

- Not for use with aggressive dogs. Do not use this product if your dog is prone to aggressive behavior. Aggressive dogs can cause severe injury or death to their owners and others. If you are not sure that this product is right for your dog, please talk to your veterinarian or a certified trainer.
- Risk of electric shock. Use the Fence Transmitter indoors in dry location only.

CAUTION

- This PetSafe® Wireless Pet Containment System® is NOT a solid barrier. The system is designed to act as a deterrent to remind pets by Static Correction to remain in the boundary established. It is important that you reinforce training with your pet on a regular basis. Since the tolerance level to Static Correction varies from pet to pet, Radio Systems® Corporation CANNOT guarantee that the system will, in all cases, keep a pet within the established boundary. Not all pets can be trained to avoid crossing the boundary! Therefore, if you have reason to believe that your pet may pose a danger to others or harm himself if he is not kept from crossing the boundaries, you should NOT rely solely upon the PetSafe® Wireless Pet Containment System® to confine your pet. Radio Systems® Corporation shall NOT be liable for any property damage, economic loss or any consequential damages, sustained as a result of any animal crossing the boundary.
- Proper fit of the collar is important. A collar worn for too long or made too tight on the pet's neck may cause skin damage. Ranging from redness to pressure ulcers; this condition is commonly known as bed sores.
 - Avoid leaving the collar on the dog for more than 12 hours per day.
 - When possible reposition the collar on the pet's neck every 1 to 2 hours.
 - Check the fit to prevent excessive pressure; follow the instructions in this manual.
 - Never connect a lead to the electronic collar; it will cause excessive pressure on the contacts.
 - When using a separate collar for a lead, don't put pressure on the electronic collar.
 - Wash the dog's neck area and the contacts of the collar weekly with a damp cloth.
 - Examine the contact area daily for signs of a rash or a sore.
 - If a rash or sore is found, discontinue use of the collar until the skin has healed.
 - If the condition persists beyond 48 hours, see your veterinarian.
 - For additional information on bed sores and pressure necrosis, please visit our website.

CAUTION

These steps will help keep your pet safe and comfortable. Millions of pets are comfortable while they wear stainless steel contacts. Some pets are sensitive to contact pressure. You may find after some time that your pet is very tolerant of the collar. If so, you may relax some of these precautions. It is important to continue daily checks of the contact area. If redness or sores are found, discontinue use until the skin has fully healed.

- You may need to trim the hair in the area of the Contact Points. Never shave the dog's neck; this may lead to a rash or infection.
- Always remove your dog's Receiver Collar before performing any Transmitter testing.
- The Receiver Collar should not be on your dog when the system is tested. Your pet may receive an unintended correction.
- The Boundary Width of the system must be tested whenever an adjustment is made to the containment field to prevent unintended corrections to your pet.
- If you use a collar and leash for training, be sure the extra collar does not put pressure on the contact points.
- Never remove power from the system when the collar is on the pet. This may activate the Receiver Collar.
- Radio Systems® Corporation recommends the use of an Uninterruptible Power Supply (UPS) for use with your wireless fence. Should the power go out at your home, your pet will be unprotected. Power outages can be unpredictable, and the use of a UPS will provide you with some time to properly restrain your pet.

In rare instances, if your pet is near the boundary at the time when the power fails, it is possible that your pet will receive a correction. This correction will stop after a 30 second timeout period has been reached. This is due to the operation of the collar: the collar is activated by the absence of the containment signal.

While results will vary depending on the UPS manufacturer's specifications the following are typical examples to guide your choice of UPS:

- Using a 400 VA UPS a consumer should expect 3 hours of backup time.
- Using a 900 VA UPS a consumer could expect 8 hours of backup time.

If settings below maximum fence size are used, additional backup time will result. At minimum fence size settings backup time may be more than two times the backup time estimated at maximum fence size.

NOTICE

- To prevent an unintended correction, after the Boundary Flags have been placed, be sure to set the static correction on the Receiver Collar back to level 1 tone only.
- Do not place anything on the top of the Transmitter or cover any ventilation holes. This may overheat the Transmitter and cause early transmit failure.
- Do not place Transmitter in a closet or any other confined, unventilated area.

Thank you for choosing PetSafe® brand. You and your pet deserve a companionship that includes memorable moments and a shared understanding together. Our products and training tools promote a lifestyle of protection, teaching, and love — essentials that influence memories for a lifetime. If you have any questions about our products or training your pet, please visit our website at www.petsafe.net or contact our Customer Care Center at 1-800-732-2677.

To get the most protection out of your warranty, please register your product within 30 days at www.petsafe.net. By registering and keeping your receipt, you will enjoy the product's full warranty and should you ever need to call the Customer Care Center, we will be able to help you faster. Most importantly, PetSafe® will never give or sell your valuable information to anyone. Complete warranty information is available online at www.petsafe.net.

Table of Contents

Components.....	5
Other Items You May Need	5
How the System Works	6
Key Definitions	6
Operating Guide	7
Set Up the Transmitter	7
Prepare the Receiver Collar	7
Battery Contact Verification	8
Adjust the Pet Area to Desired Size	9
Transmitter Range Chart	10
Place the Boundary Flags	10
Fit the Receiver Collar	11
Training Guide	12
Be Patient With Your Pet	12
Day 1 - Boundary Awareness	13
Days 2 thru 4 - Continue Boundary Awareness	14
Days 5 thru 8 - Distraction Phase	14
Days 9 thru 14 - Unleashed Supervision	15
Days 15 thru 30 - Pet Monitoring	15
Taking Your Pet Out of the Pet Area	15
Wireless - To - Go	16
Accessories.....	16
Frequently Asked Questions	16
Troubleshooting	18
Re-synchronize the System	20
Terms of Use and Limitation of Liability	20
Compliance	21
Customer Care International.....	21
Perchlorate Battery	21
Mounting Template.....	24

Components

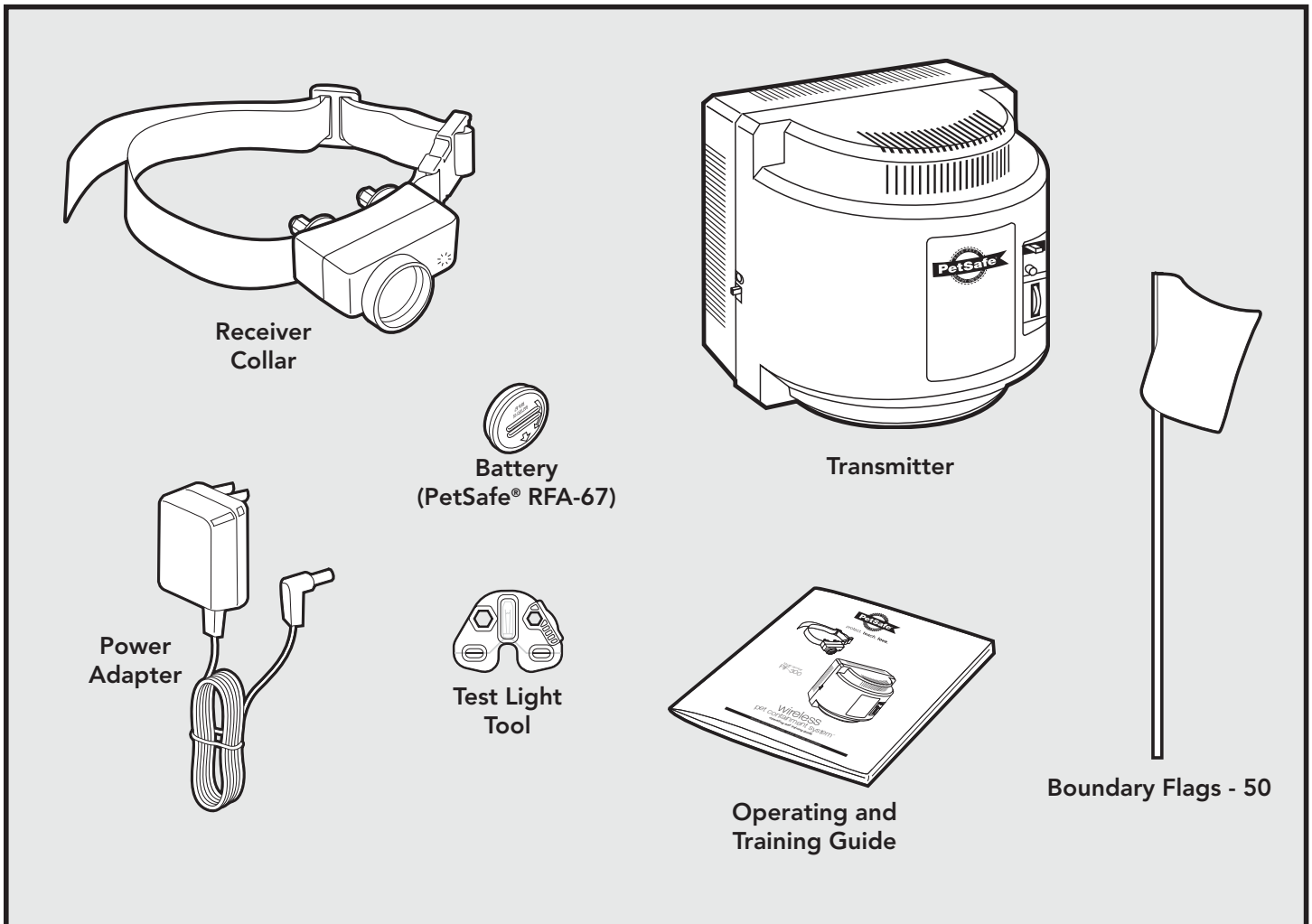

Other Items You May Need

- Pliers
- Scissors
- Lighter
- Drill & mounting hardware
- Tape measure
- Non-metallic collar and leash

Set up and training help: www.petsafe.net

Want professional installation help? Invisible Fence® Brand installers will come to your home and install your new PetSafe® System for an additional cost. Contact your local dealer at 1-877-866-DOGS(3647) or visit our website at www.invisiblefence.com for more information.

How the System Works

The PetSafe® Wireless Pet Containment System® has been proven safe, comfortable, and effective for pets over 8 pounds. The system works by transmitting a radio signal up to 90 feet in all directions. You temporarily define the Pet Area with Boundary Flags for a visual aid in training your pet. Your pet wears a Receiver Collar with Contact Points that touch his neck, and, once trained, is allowed to roam freely in the Pet Area. When your pet reaches the Boundary Zone, the Receiver Collar gives a warning beep before delivering a safe Static Correction through the Contact Points to get his attention until he returns to the Pet Area.

Key Definitions

Transmitter: Transmits the radio signal and is the center of the Pet Area.

Pet Area: Distance from the Transmitter where your pet can roam freely.

Boundary Zone: 2 to 3 foot wide area outside the Pet Area where your pet's Receiver Collar will begin to beep and then begin to deliver a Static Correction. The correction will start in the Boundary Zone and continue anywhere beyond the Pet Area.
Note: The Receiver Collar is equipped with a safety time-out feature that will stop correcting after 30 seconds if your pet remains outside the Pet Area.

Receiver Collar: Receives the radio signal from the Transmitter.

Correction Level Button: Adjusts the level of Static Correction your pet receives outside the Pet Area.

Receiver Indicator Light: Indicates the level of correction at which the Receiver Collar is set. This light also serves as a low battery indicator.

Contact Points: Deliver the safe Static Correction when your pet moves into the Boundary Zone.

Power Jack: Where the Power Adapter plugs into the Transmitter. The Transmitter is powered by a standard 120-volt outlet.

Boundary Switch: Adjust according to the size of the Pet Area desired. *Note: Adjusting the switch does not change the level of Static Correction on the Receiver Collar.*

Power Light: Indicates when the Transmitter is on.

Boundary Control Dial: Adjusts the distance from the Transmitter to the Boundary Zone. *Note: Adjusting the dial does not change the level of Static Correction on the Receiver Collar.*

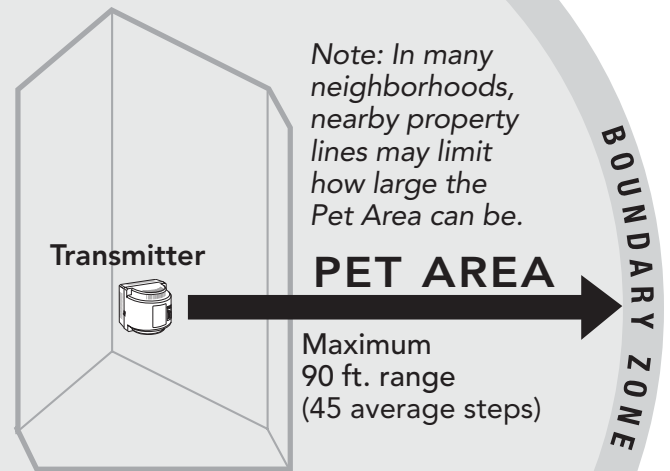

Receiver Collar

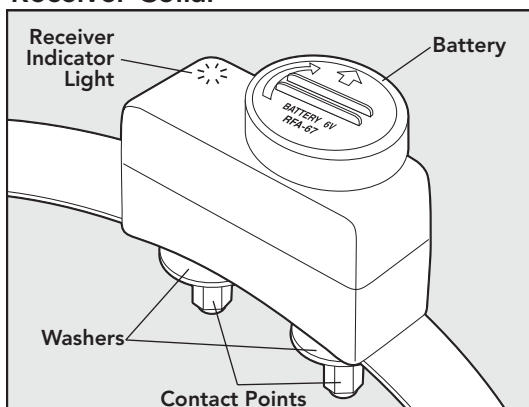

Transmitter

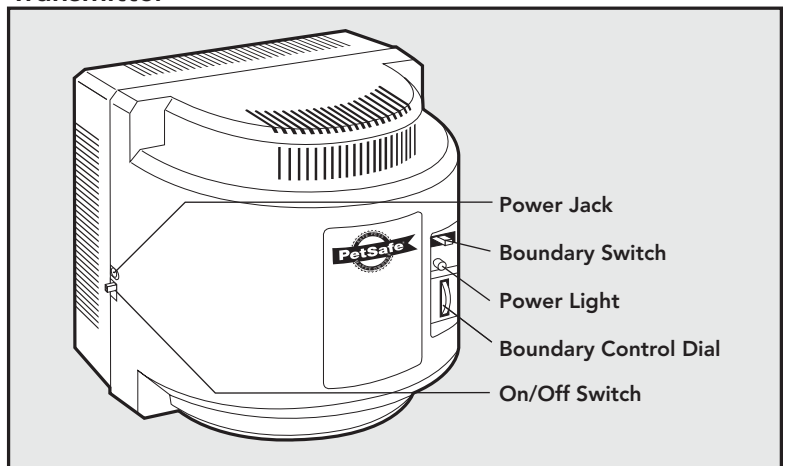

Operating Guide

Step 1 Set Up the Transmitter

Important: You may need to move the Transmitter several times before determining the final location.

The Transmitter is located at the exact center of the Pet Area. Place the Transmitter:

- At least 2 feet above the floor located on the ground floor of your home.
- In a dry, well ventilated, protected area.
- In an area where temperatures do not fall below freezing (e.g., garage, shed, closet).
- On a non-metal table or mount on a wall (1A). A mounting template is included on the back of this guide.
- At least 3 feet from large metal objects, as these items may reduce the size and shape of your Pet Area (1B).

To maximize your Pet Area, make sure the Boundary Switch is on "High" and the Boundary Control Dial is set to "8". Plug Power Adapter into Power Jack and standard 120-volt outlet. Turn the Transmitter on.

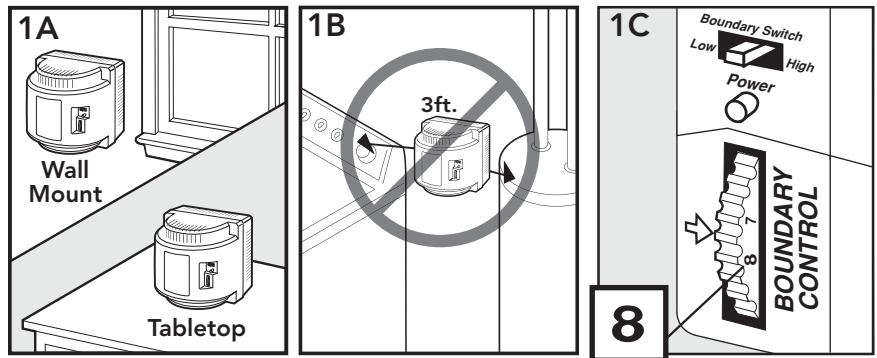

Step 2 Prepare the Receiver Collar

Your Receiver Collar comes with short Contact Points. Long Contact Points for pets with long or thick hair are available through our Customer Care Center at 1-800-732-2677. Tighten the Contact Points using the Test Light Tool (2A) one-half turn beyond finger tight. Check the tightness weekly.

To Insert and Remove the Receiver Collar Battery

Note: Do not install the battery while the Receiver Collar is on your pet.

This Receiver Collar utilizes a replaceable PetSafe® battery (RFA-67). This unique battery is designed to make battery replacement easier and increase water protection.

To insert the battery, align the symbols on the battery (arrow) and Receiver Collar (triangle) (2B). Use the edge of the Test Light Tool (2B) to turn the battery clockwise until the arrow lines up with the lock symbol on the housing.

To remove the battery, turn the battery counter-clockwise using the edge of the Test Light Tool (2C). DO NOT attempt to cut into or pry open the battery. Be sure to discard the used battery properly.

A replacement PetSafe® battery (RFA-67) can be found at many retailers. Contact the Customer Care Center at 1-800-732-2677 or visit our web site at www.petsafe.net to locate a retailer near you.

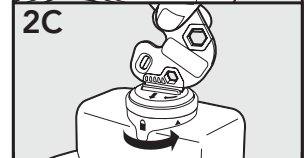
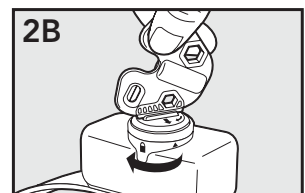
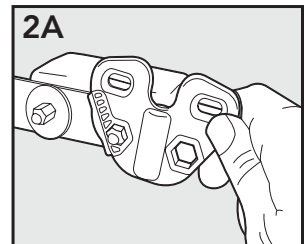

To Set the Static Correction Level

Read all steps before attempting to set the Static Correction Level.

1. Remove the clear plastic cover with the edge of the Test Light Tool to expose the Correction Level Button (2D).
2. With the battery installed, press the Correction Level Button and release when the Receiver LED Indicator Light lights up (2E).
3. The Receiver LED Indicator Light will emit a series of flashes representing the Static Correction Level.
4. Increase the Static Correction Level by pressing and releasing the Correction Level Button within 5 seconds of the previous series of flashes.

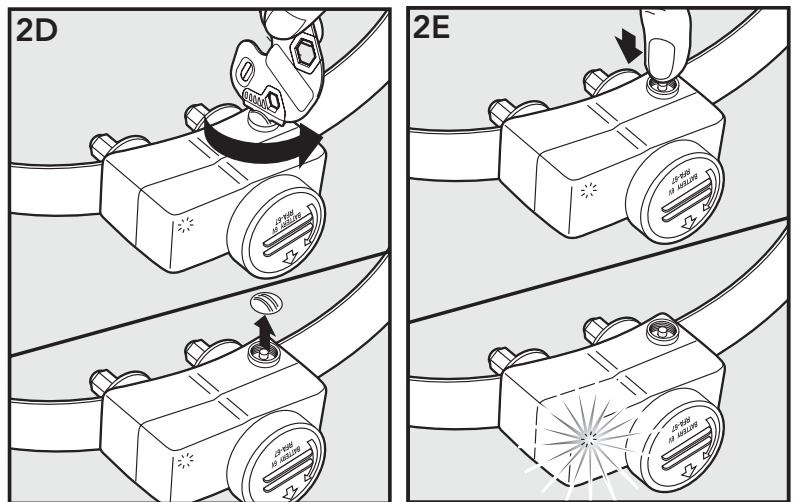

5. After setting the Static Correction Level, replace the cover to protect the Correction Level Button.

The Static Correction levels increase in strength from 1 to 6. Pushing the Correction Level Button while the Receiver Collar is on level 6 will cause the Receiver Collar to revert to level 1. Refer to the Function and Response Table to choose the Static Correction level that best fits your pet.

The Receiver Indicator Light acts as a low battery indicator. The light will flash every 4 to 5 seconds when battery replacement is required.

Battery Contact Verification

Remove Receiver Collar from your pet. Press the button and verify that the LED light illuminates. If the LED light does not come on remove the battery. Locate the metal tabs in the battery well. Gently lift the tabs to ensure that the battery will make good contact. Replace the battery into the Receiver Collar. Press the button and check that the LED light illuminates.

Function and Response Table

Indicator Light Response	Static Correction Level	Receiver Collar Function	Temperament of Pet
1 Flash	1	No Static Correction, Tone Only	Initial Training Mode
2 Flashes	2	Low Static Correction	Timid
3 Flashes	3	Medium-Low Static Correction	Timid or Average
4 Flashes	4	Medium Static Correction	Average Energy
5 Flashes	5	Medium-High Static Correction	Average or High Energy
6 Flashes	6	High Static Correction	High Energy
Flashes once every 4 to 5 seconds		Indicates Low Battery	

Over Correction Protection

If your pet enters the Boundary Zone or continues anywhere beyond the Pet Area, this feature limits the Static Correction duration to 30 seconds.

In the unlikely event that your pet leaves the Pet Area, he will not receive a Static Correction upon return to the Pet Area.

Step 3 Adjust the Pet Area to Desired Size

3

Make sure the entire Pet Area lies within your property boundaries (3A). Always start determining the Boundary Zone at the shortest distance from Transmitter. Place the Boundary Switch on "Low" if the Boundary Zone will be less than 45 feet from the Transmitter.

Make sure the Receiver Collar battery is properly installed, the Static Correction level is set at 2 or greater, and the Test Light Contacts are touching the Contact Points (3B).

Note: If your next-door neighbor has an In-Ground containment system, see Troubleshooting section page 19.

Test Light Instructions

1. Set the Correction Level to 2 or above.
2. Hold the Test Light Contacts to the Contact Points.
3. Walk toward the Boundary Zone holding the Receiver collar at your pet's neck level until the Test Light flashes.

Save Test Light for future testing.

Note: If the Test Light does not flash, install a new battery and re-test. If Test Light still does not flash, contact the Customer Care Center at 1-800-732-2677.

To maximize your Pet Area, make sure the Boundary Switch is on "High" and the Boundary Control Dial is set to "8". Plug Power Adapter into Power Jack and standard 120-volt outlet.

Two-Person Method

Hold the Receiver Collar at your pet's neck height (3C) with logo side facing away from the Transmitter and Contact Points facing upwards. Walk to the edge of the desired Pet Area. Facing away from the Transmitter, hold the Receiver Collar at the edge of the desired Pet Area (3D).

Starting with the Boundary Control Dial set to "8", have a second person turn the dial down SLOWLY. When the Receiver Collar starts to beep, tell the person to stop turning the Boundary Control Dial. Record your settings below for future reference.

One-Person Method

Measure the shortest distance from the desired Boundary Zone to the Transmitter. Find the distance on the Transmitter Range Chart on page 10 and set the Boundary Switch and Boundary Control Dial. Hold the Test Light Contacts to the Contact Points (3B). Take the Receiver Collar to the Boundary Zone with the logo side facing away from the Transmitter and Contact Points facing upwards (3C). Hold the Receiver Collar at your pet's neck level (3D) until the Receiver Collar beeps and the Test Light flashes. If the Receiver Collar beeps before or after the desired Boundary Zone, return to the Transmitter and adjust the Boundary Control Dial. Repeat this process until the Receiver Collar is beeping at the desired location. Record your settings on page 10 for future reference.

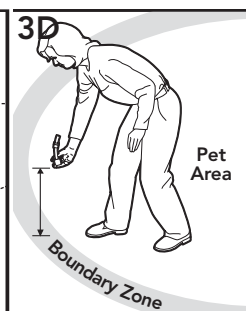
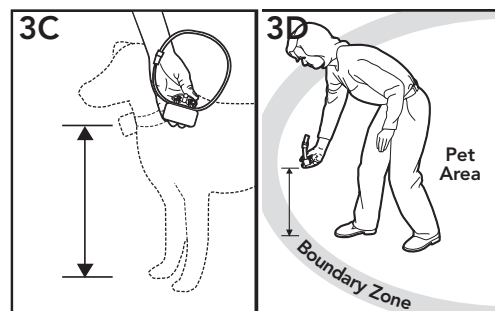
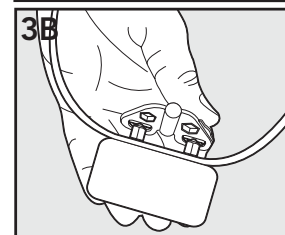
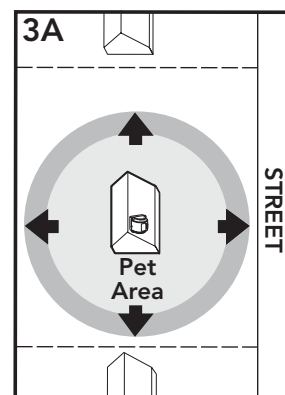

Transmitter Range Chart

Boundary Control Dial Position	Boundary Switch LOW	Boundary Switch HIGH
1	5-10 ft.	5-10 ft.
2	5-10 ft.	5-10 ft.
3	15-20 ft.	25-35 ft.
4	20-25 ft.	42-55 ft.
5	25-30 ft.	55-65 ft.
6	35-40 ft.	75-85 ft.
7	40-45 ft.	85-90 ft.
8	40-45 ft.	85-90 ft.

Note: These distances are approximate.

Record Your Settings

	Final Boundary Switch Setting (HIGH or LOW)	Final Boundary Control Dial Position (1-8)	Receiver Static Correction Level (1-6)
Home			
Camping			
Vacation			
Other			

Step 4 Place the Boundary Flags

4

The Boundary Flags are visual reminders for your pet of where the Boundary Zone is located. The Receiver Collar will activate within 2 to 3 feet of the Boundary Flags.

- Using the Test Light, with the Static Correction Level set at 2 or greater, hold the Receiver Collar at your pet's neck height with logo side facing away from the Transmitter.
- Walk towards the Boundary Zone until the Receiver Collar beeps and the Test Light flashes. (4A).
- Place a Boundary Flag in the ground (4B).
- Walk back into the Pet Area until the beeping stops.
- Repeat this process around the Boundary Zone until it is marked with Boundary Flags every 10 feet.

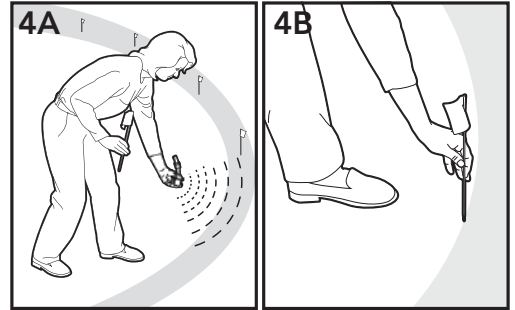

The Boundary Flags may be in different parts of the Boundary Zone and may not be in a line. The Boundary Zone is 2 to 3 feet wide.

Step 5 Fit the Receiver Collar

5

Important: The proper fit and placement of your Receiver Collar is important for effective training. The Contact Points must have direct contact with your pet's skin on the underside of his neck.

CAUTION

Please read and follow the instructions in this manual. Proper fit of the collar is important. A collar worn for too long or made too tight on the pet's neck may cause skin damage. Ranging from redness to pressure ulcers; this condition is commonly known as bed sores.

- Avoid leaving the collar on the dog for more than 12 hours per day.
- When possible reposition the collar on the pet's neck every 1 to 2 hours.
- Check the fit to prevent excessive pressure; follow the instructions in this manual.
- Never connect a lead to the electronic collar; it will cause excessive pressure on the contacts.
- When using a separate collar for a lead, don't put pressure on the electronic collar.
- Wash the dog's neck area and the contacts of the collar weekly with a damp cloth.
- Examine the contact area daily for signs of a rash or a sore.
- If a rash or sore is found, discontinue use of the collar until the skin has healed.
- If the condition persists beyond 48 hours, see your veterinarian.
- For additional information on bed sores and pressure necrosis, please visit our website.

These steps will help keep your pet safe and comfortable. Millions of pets are comfortable while they wear stainless steel contacts. Some pets are sensitive to contact pressure. You may find after some time that your pet is very tolerant of the collar. If so, you may relax some of these precautions. It is important to continue daily checks of the contact area. If redness or sores are found, discontinue use until the skin has fully healed.

You may need to trim the hair in the area of the Contact Points. Never shave the dog's neck; this may lead to a rash or infection.

To assure a proper fit, please follow these steps:

1. Make sure that the battery is not installed in the Receiver Collar.
2. Start with your pet standing comfortably (5A).
3. To make it easier to hear the warning tone, place the Receiver Collar on your pet with the logo side of Receiver facing up.
4. Center the Contact Points underneath your pet's neck, touching the skin.

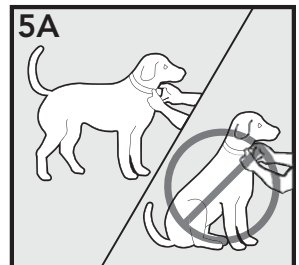

CAUTION

You may need to trim the hair in the area of the Contact Points. Never shave the dog's neck; this may lead to a rash or infection.

5. Check the tightness of the Receiver Collar by inserting one finger between the end of a Contact Point and your pet's neck. The fit should be snug but not constricting (5B).
6. Allow your pet to wear the collar for several minutes then recheck the fit. Check the fit again as your pet becomes more comfortable with the Receiver Collar.
7. Trim the collar as follows (5C):
 - a. Mark the desired length of the Receiver Collar with a pen. Allow for growth if your pet is young or grows a thick winter coat.
 - b. Remove the Receiver Collar from your pet and cut off the excess.
 - c. Before placing the Receiver Collar back onto your pet, seal the edge of the cut collar by applying a flame along the frayed edge.
8. Put battery in Receiver Collar.

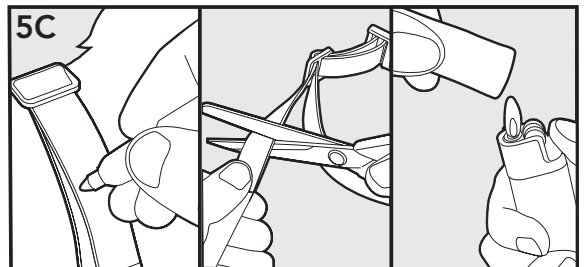

To Re-Thread the Collar

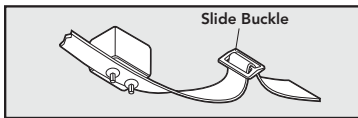

The slide buckle prevents the collar from becoming loose around your pet's neck.

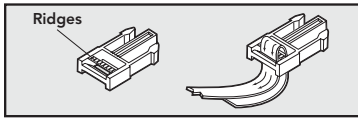

The ridges must be facing up; the collar will slip if it is not properly threaded.

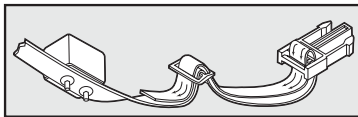

Training Guide

Be Patient With Your Pet

Important: Proper training of your pet is essential to the success of the PetSafe® Wireless Pet Containment System®. Read this section completely before beginning to train your pet. Remember that the PetSafe® Wireless Pet Containment System® is not a solid barrier.

- Have fun with your pet throughout the training process. Training should be fun, fair, firm and consistent.
- Train for 10 to 15 minutes at a time. Don't try to do too much too quickly. More-frequent short sessions are better than less-frequent longer sessions.
- We suggest a minimum of 14 days of training. Depending on your pet and how he learns, the training could take more or less time.
- If your pet shows signs of stress, slow down the training schedule, add additional days of training, or increase the amount of play time with your pet in the Pet Area. Common stress signals include:
 - Pet pulling on leash toward the house
 - Ears tucked
 - Tail down
 - Body lowered
 - Nervous / frantic movement or stiffening of pet's body
- Your pet must be completely comfortable near the Boundary Flags at the end of every training session. Spend at least 5 minutes of "play time" at the completion of each session within 10 feet of the Boundary Flags.
- Finish each training session on a positive note with lots of praise and play.
- Remove the Receiver Collar after each training session.
- Be sure to contain your pet by another means during the training period (e.g. pen, tie-out, leash, etc.).
- During training, if you need to take your pet out of the Pet Area, remove the Receiver Collar and either pick your pet up or put him in the car to pass out of the Pet Area.
- Even if you think your pet is responding well to the training, complete the entire training. Reinforcement is important!

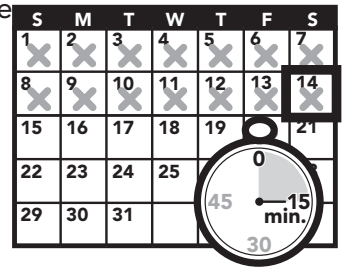

Phase 1 Day 1 - Boundary Awareness

1

Tone Only Training Mode

Perform three sessions on day 1, each training session lasting 10-15 minutes.

Goal:

To have your pet learn that the Boundary Flags and warning beep from the Receiver Collar define the new Pet Area.

Setup:

- Program the Static Correction Level on the Receiver Collar to Level 1 Tone Only training mode.
- Put a separate non-metallic collar on your pet's neck ABOVE the Receiver Collar and attach a leash.

CAUTION

Be sure the extra collar does not put pressure on the Contact Points.

- Have tiny pieces of treats that your pet will find desirable available (hot dogs or lunch meat work well).
- Have your pet's favorite play toy available.

Steps:

1. Begin by walking your pet on a leash in the Pet Area. Calmly praise and talk to your pet.
2. Move toward the Boundary Flags (1A). Keep your mood happy.
3. With full control of your pet on a leash, walk to the flags. As your pet enters the Boundary Zone, the Receiver Collar will begin to tone (1B). Allow your pet to stay in the Boundary Zone for up to 2 seconds then gently help him back into the Pet Area (1C). Immediately praise and offer your pet a treat as he enters the Pet Area, even if you have helped with the leash.
4. Repeat this process at the same Boundary Flag until your pet resists going into the Boundary Zone.
5. Aim to master 3-4 Boundary Flags per session. Make this FUN! Praise if your pet quickly retreats or resists going into the Boundary Zone.

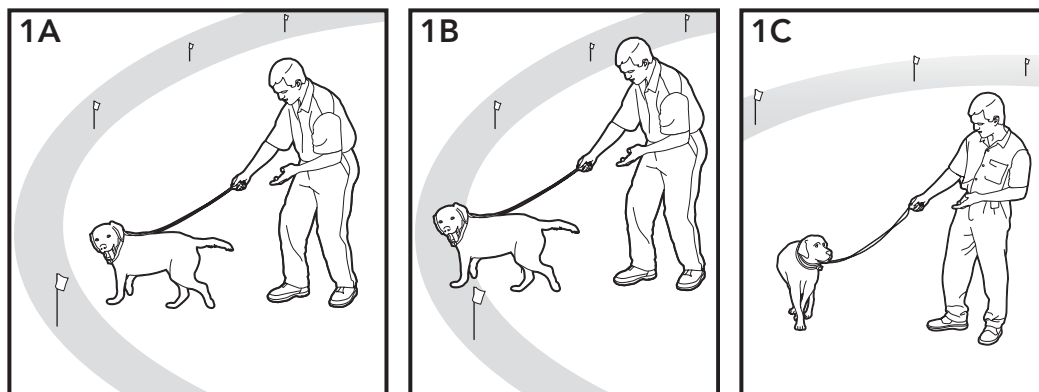

Phase 2 Days 2 thru 4 - Continue Boundary Awareness

2

Awareness

Introduction to Static Correction

Perform three sessions per day, each lasting 10-15 minutes.

Goal:

To train your pet to stay in the Pet Area and respect the boundary.

Setup:

- Program the Static Correction Level on the Receiver Collar to Level 2.
- Put a separate non-metallic collar on your pet's neck ABOVE the Receiver Collar and attach a leash.

CAUTION

Be sure the extra collar does not put pressure on the Contact Points.

- Have tiny pieces of treats available (hot dogs or lunch meat work well).
- Have your pet's favorite play toy available.

Steps:

1. Repeat steps 1-5 in Phase One.
 2. If your pet does not respond to the Static Correction, confirm that the Receiver Collar is fitting properly according to Step 5 on page 11.
 3. If the Receiver Collar is fitted properly and your pet does not respond to the Static Correction, increase the Static Correction Level by 1. Watch for slight reactions at first such as ears up, head turned, looking at the ground.
 4. Stay at the same flag until your pet resists going into the Boundary Zone.
-

Phase 3 Days 5 thru 8 - Distraction Phase

3

Perform three training sessions per day, each lasting 10 to 15 minutes.

Goal:

To train your pet to stay within the Pet Area with distractions outside of the Pet Area.

Setup:

- Program the Static Correction Level on the Receiver Collar to level 2 or higher depending on the reaction results from days 2 thru 4.
- Put a separate non-metallic collar on your pet's neck ABOVE the Receiver Collar and attach a leash.

CAUTION

Be sure the extra collar does not put pressure on the Contact Points.

- Have tiny pieces of treats available (hot dogs or lunch meat work well).
- Have your pet's favorite play toy available.
- Create distractions to tempt your pet to enter the Boundary Zone, such as:
 - Have a family member cross from inside the Pet Area to outside of it.
 - Throw a ball or treat outside of the Pet Area.
 - Have a neighbor walk their pet outside of the Pet Area.
- Gradually increase distraction level. **Never coax or call your pet out of the Pet Area.**

Steps:

1. With full control of your pet on a leash, have the distraction presented.
2. If your pet does not move toward the distraction, praise and offer a treat.
3. If your pet does react to the distraction, allow him to go into the Boundary Zone.
4. Help your pet back into the Pet Area if he does not turn back after 2 seconds.
5. Treat and praise your pet anytime he comes back into the Pet Area with or without help.
6. Repeat this process with other distractions. Use other family members during this process.
7. If your pet does not respond to the Static Correction, confirm that the Receiver Collar is fitting properly according to Step 5 on page 11.
8. If the Receiver Collar is fitted properly and if your pet does not respond to the Static Correction, increase the Static Correction Level by 1.

Phase **Days 9 thru 14 - Unleashed Supervision**

4

Training sessions should start at 10-15 minutes, gradually increasing to over an hour.

Your pet is ready for this step only when he clearly avoids the entire Boundary Zone, regardless of any distractions or temptations. During this step, do not leave your pet unattended.

Goal:

To give your pet free run of the Pet Area off the leash.

Setup:

Adjust the Receiver Collar to the permanent setting appropriate for your pet.

Steps:

1. Enter the Pet Area with your pet wearing the Receiver Collar.
2. Walk around the yard and play with your pet, staying within the Pet Area at all times.
3. Preoccupy yourself with another task in the yard while watching your pet.
4. Should your pet escape, take the Receiver Collar off and lead him back into the Pet Area.

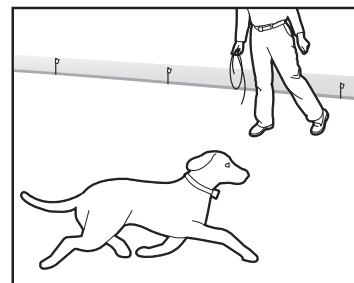

Phase **Days 15 thru 30 - Pet Monitoring**

5

Your pet is ready to run! Check in on your pet at regular intervals.

Note: After you are satisfied your pet's training is complete, remove every other Boundary Flag every 4 days until all flags are removed. Save Boundary Flags for future use.

Taking Your Pet Out of the Pet Area

Important: Remove the Receiver Collar and leave it in the Pet Area.

Once your pet learns the Boundary Zone, he will be reluctant to cross it for walks or car rides.

Option 1: Replace the Receiver Collar with a regular collar. Put your pet in a car that is within the Pet Area and drive him out of the Pet Area.

Option 2: Replace the Receiver Collar with a regular collar and leash. Walk your pet out of the Pet Area while giving a command such as "OK" at a specific place of the Boundary Zone (the end of your driveway, sidewalk, etc.). Always leave the Pet Area with a leash at this place and your pet will associate leaving the Pet Area only on a leash, only at this place, and only with a person. You may initially need to convince your pet to leave the Pet Area with a food treat and lots of praise.

Note: You may also carry your pet out of the Pet Area.



Congratulations!
You have now
successfully completed
the training program.

Wireless - To - Go

Your PetSafe® Wireless Pet Containment System® is completely portable. Follow the set-up procedures (steps 1 through 4) wherever you wish to have containment of your pet. Reestablish the Pet Area and mark it with Boundary Flags so your pet knows his Boundary Zone. Note: If setting up in a metal building or vehicle, the maximum size of the Pet Area may be reduced. Be sure to remove the Receiver Collar battery before turning off the Transmitter. If you want to power the Transmitter from a car or other DC source, use an inverter rated for 50 watts or more.

Accessories

To purchase additional accessories for your PetSafe® Wireless Pet Containment System®, contact the Customer Care Center at 1-800-732-2677 or visit our website at www.petsafe.net to locate a retailer near you.

Component	Part Number
Battery - two pack	RFA-67D-11
Extra Wireless Containment System Receiver Collar	PIF-275-19
Power Adapter	RFA-374
Replacement Collar	RFA-449
Extra Flags	RFA-2
Extra Wireless Transmitter	IF-100
Accessory Pack	RFA-281
Stay + Play Wireless Fence™ Receiver Collar	PIF00-12918
Stay + Play Wireless Fence™ Transmitter and Adapter	PIF00-13210
Stay + Play Receiver Collar Charger	RFA-463

Frequently Asked Questions

Is the Receiver Collar waterproof?	<ul style="list-style-type: none"> • Yes. When changing the battery, be sure to keep the battery area free from dirt and debris.
Will the PetSafe® Wireless Pet Containment System® cover a larger circle than 180 feet across?	<ul style="list-style-type: none"> • You can use another Wireless Transmitter with overlapping boundaries of at least 5-10 feet to increase the size of the Pet Area.
Will a sloping yard or hills affect the Pet Area?	<ul style="list-style-type: none"> • The Transmitter signal extends 90 feet in all directions. A sloping yard or a yard with hills can cause the Pet Area to appear less or more than expected. Consider repositioning the Transmitter to maximize your Pet Area.
Can I use more than one Receiver Collar with the Wireless System?	<ul style="list-style-type: none"> • Yes. There is no limit to the number of pets you can contain with the Wireless System. You must purchase an additional Wireless Pet Containment Receiver Collar for each pet. Contact the Customer Care Center at 1-800-732-2677 or visit our website at www.petsafe.net to locate a retailer near you.
Will the Wireless System keep other pets out of my yard?	<ul style="list-style-type: none"> • No. The Wireless System is only effective on pets who wear the Receiver Collar.
Is there a hand-held remote Transmitter that will work with the Wireless System Receiver Collar?	<ul style="list-style-type: none"> • No. You would need to purchase a separate Remote Training System. Contact the Customer Care Center at 1-800-732-2677 or visit our website at www.petsafe.net to locate a retailer near you.
Is there a smaller Receiver Collar or another compatible Receiver Collar that I can use with the Wireless Transmitter?	<ul style="list-style-type: none"> • Yes. The Stay + Play Wireless Fence™ Receiver Collar is sized for pets weighing over 5 pounds with neck sizes from 6 inches to 23 inches. A Receiver Collar charger is required for this Receiver Collar.

If I have a question about my Wireless System or need replacement parts, where can I get answers or service?	<ul style="list-style-type: none"> • Contact the Customer Care Center at 1-800-732-2677 or visit our web site at www.petsafe.net.
Can I use the Wireless System on an aggressive pet?	<ul style="list-style-type: none"> • We do not recommend using any electronic training devices on aggressive pets. If you are unsure if your dog is aggressive, please consult your veterinarian or a certified trainer.
Can I use the Wireless System on a cat?	<ul style="list-style-type: none"> • The Wireless System can be used as long as the cat can comfortably wear the Receiver Collar.
What happens if the power goes out?	<ul style="list-style-type: none"> • The Wireless System is designed to recognize power outages and shuts down without activating the Receiver Collar. However, if your pet is near the Boundary Zone during the power failure, he may receive a Static Correction.
What can happen if I turn off or unplug the Transmitter power?	<ul style="list-style-type: none"> • If your dog is wearing the Receiver Collar, he may receive an unintended correction. Always remove your dog's Receiver Collar before removing power from the Transmitter or before performing any Transmitter testing.
What if I lose the clear plastic cover for the Correction Level Button?	<ul style="list-style-type: none"> • The clear plastic cover prohibits the Static Correction Level from accidentally being changed and also helps keep the Receiver waterproof. Contact the Customer Care Center at 1-800-732-2677 for a replacement.
If my pet leaves the Pet Area, how long will he be corrected?	<ul style="list-style-type: none"> • Your pet will receive Static Correction as long as he is outside the Pet Area, for up to 30 seconds. The Receiver Collar has a safety time-out to stop correcting and toning after 30 seconds until it is returned to the Pet Area.
How often do I need to replace the Receiver Collar battery?	<ul style="list-style-type: none"> • Battery life depends on how frequently your pet tests the Boundary Zone. The Receiver Indicator Light acts as a low battery indicator, flashing every 4 to 5 seconds when replacement is required.
Can I place the Receiver on another collar?	<ul style="list-style-type: none"> • Yes. You may use any non-metallic collar. Make 2 holes in the collar to attach the Receiver. Use the collar in the kit as a template to locate the holes on the new collar.
Do I need to perform maintenance on my Wireless System?	<ul style="list-style-type: none"> • Check your pet's neck daily for irritation from the Contact Points. • Check the Contact Points on the Receiver Collar weekly to make sure they are tight and clean. • Check the fit of the Receiver Collar weekly. • The Receiver Indicator Light acts as a low battery indicator, flashing every 4 to 5 seconds when replacement is required.
How do I know the battery in the Receiver Collar is still working?	<ul style="list-style-type: none"> • Take the Receiver Collar off your pet and walk into the Boundary Zone. The Receiver Collar should tone. If not, replace the battery.
Will vehicles, buildings and landscape features (trees, shrubs, etc.) affect the performance of the Wireless System?	<ul style="list-style-type: none"> • Yes. Placing the Transmitter inside a metal building can reduce the maximum range of the Wireless System. • Parking a vehicle within the Pet Area, can reduce the range of the system and cause your pet to receive a Static Correction where it otherwise would not if the vehicle was not there. • Fixed large metal objects such as metal sheds can affect the signal by reducing the maximum range of the system at the location of the object. As a result, your pet may receive a Static Correction.
What do I do if my pet's neck becomes red and irritated?	<ul style="list-style-type: none"> • This condition is due to the Contact Points irritating the skin. Discontinue use of the Receiver Collar for a few days. If the condition persists beyond 48 hours, see your veterinarian. Once the skin returns to normal, replace the Receiver Collar and monitor the skin condition closely.
Can I attach a leash to the Receiver Collar?	<ul style="list-style-type: none"> • No. This can result in pulling the Contact Points too tightly against your pet's neck. Attach a leash to a separate, non-metallic collar positioned above the Receiver Collar.
Why does my Receiver Collar have a tone only mode?	<ul style="list-style-type: none"> • The tone only mode can be used in training your pet to his boundary or for well-trained pets that no longer require Static Correction.

Troubleshooting

<p>The Receiver Collar is not beeping when setting up the Boundary Zone.</p>	<ul style="list-style-type: none"> • The tone may be difficult to hear in a noisy environment. • Use Test Light as explained in the “Test Light Instructions” section, and use it to determine the location of Boundary Zone. • Check that the Transmitter is set up according to directions and install a new battery while standing within 5-10 feet of the Transmitter. • Re-Synchronize the System. (Page 20)
<p>The Receiver Collar is not beeping or administering a Static Correction.</p>	<ul style="list-style-type: none"> • Check that the Transmitter is plugged into a working 120-volt outlet, turned on, the Power Light is on, and the Transmitter controls are set at your desired settings. • Check Receiver battery to make sure it is installed properly. • When replacing the battery, do so while standing within 5-10 feet of the Transmitter. • Re-Synchronize the System. (Page 20)
<p>The Receiver Collar is beeping everywhere.</p>	<ul style="list-style-type: none"> • Check that the Transmitter is plugged into a working standard 120-volt outlet, turned on, the Power Light is on, and the Transmitter controls are set at your desired settings. • Bring Receiver Collar while standing within 5-10 feet of the Transmitter to reset. • Re-Synchronize the System. (Page 20)
<p>The Receiver Collar is beeping inside the house.</p>	<ul style="list-style-type: none"> • It is recommended to remove the Receiver Collar from your pet when indoors to avoid activation of the Receiver Collar. • Make sure the Transmitter is on and set up according to the directions. • Ensure the entire house is within the Pet Area. The Transmitter may need to be moved to adjust the Pet Area to include the entire house. • If relocating the Transmitter, remove the Receiver Collar from your pet before turning the Transmitter off.
<p>My pet is receiving a Static Correction in his metal crate.</p>	<ul style="list-style-type: none"> • The Receiver Collar activates when it loses the Transmitter signal. The metal crate may block the Transmitter signal which causes the Receiver Collar to activate. • Remove the Receiver Collar from your pet when placing him in his metal crate.
<p>The Boundary Zone seems to fluctuate.</p>	<ul style="list-style-type: none"> • This is normal for the electro magnetic field of the Wireless System. The field may be affected by surrounding “electronic noise,” which can cause it to fluctuate up to 5%. • Where the Receiver Collar activates is influenced by the speed and orientation of the Receiver Collar as your pet enters the Boundary Zone.
<p>The Receiver Collar activates in the middle of the yard.</p>	<ul style="list-style-type: none"> • The Receiver Collar activates when it loses the Transmitter signal. This sometimes occurs if a large metal object is between the Receiver Collar and Transmitter, if the orientation of the Receiver Collar changes near the Boundary Zone, or if the surrounding “electronic noise” interferes with the signal. If this continues to occur, consider relocating the Transmitter and resetting the Pet Area. • Re-Synchronize the System. (Page 20)

<p>The Receiver Collar is beeping but my pet is not responding to the Static Correction.</p>	<ul style="list-style-type: none"> • Make sure the Static Correction Level is set at 2 or above. • Test the Receiver Collar with the Test Light. • If the Test Light flashes, check the fit of the Receiver Collar. • Trim your pet's fur where the Contact Points touch the neck and/ or purchase long Contact Points by contacting the Customer Care Center at 1-800-732-2677. • Increase the Static Correction Level. • Repeat training steps to reinforce training.
<p>My pet reacts strongly to the Static Correction and has become fearful.</p>	<ul style="list-style-type: none"> • Lower the Static Correction Level. • Make sure you are in control of the situation when your pet receives his first Static Corrections (have him on a leash attached to a separate, non-metallic collar) and lead him into the Pet Area and praise him. If your pet remains fearful, suspend training and start again the next day. Make sure to end all training sessions on a positive note with lots of praise and play.
<p>The Power Light is not on.</p>	<ul style="list-style-type: none"> • Make sure the Transmitter On/Off Switch is on and the Power Adapter is plugged into the Transmitter and a working standard 120-volt outlet.
<p>I was setting up the Pet Area and after I turned down the Boundary Control Dial, the Receiver Collar would no longer beep or correct.</p>	<ul style="list-style-type: none"> • You may have turned the Boundary Control Dial down too quickly, causing the Receiver Collar to go into power-fail mode. This is a safety feature designed to protect your pet when power to the Transmitter goes out. With the Receiver Collar while standing within 5-10 feet of the Transmitter, turn the Boundary Control Dial to "8" and reset the Boundary Zone, making sure to turn the dial down slowly.
<p>My next-door neighbor has an In-Ground Containment System and the Receiver Collar does not activate near their property.</p>	<ul style="list-style-type: none"> • Your neighbor's In-Ground Fence signal may interfere with the operation of the Receiver Collar preventing activation close to their fence. To minimize the interference, reduce the size of the Pet Area or move the Transmitter away from the In-Ground Fence System. • Adjust the Pet Area so that the Receiver Collar activates for at least 5 feet beyond the reduced Boundary setting when walking towards the In-Ground Fence.
<p>The Receiver Collar has injured my pet's neck.</p>	<ul style="list-style-type: none"> • Failing to follow the important safety information at the front of the Operating and Training Guide has caused pressure ulcers. Some descriptions of advanced pressure ulcers describe the sores as looking like burns on the dog's neck. Be assured that electronic collars do not use enough energy to create electrical burns. The energy in an output pulse is only a few thousandths of a Joule; it is similar in nature to the static pulse that you may feel when getting out of your car. In some cases, pressure ulcers are described as chemical burns. The RFA-67 battery is sealed when installed in the Receiver Collar housing. This sealing makes it virtually impossible, without misuse or abuse, for your Receiver Collar battery to leak onto your pet's neck. Please review and follow the important safety information on page 2, and the instructions in Step 5 under the heading "Fit the Receiver Collar" on page 11.

Re-synchronize the System

1. Remove the Receiver Collar from your pet.
2. Remove the battery from the Receiver Collar. Discharge all power by holding the correction level button down until the LED is no longer illuminated.
3. At the transmitter, move the Boundary Switch from the low to the high position.
4. Slowly adjust the Boundary Control Dial up to 8, down to 1 and then back to the #4 position.
5. Standing within 5-10 feet of the Transmitter, reinsert the battery into the Receiver Collar.
6. Test the Boundary and verify operation by walking out into the Pet Area until your Receiver Collar responds. (With the Transmitter set to 4, it should activate approximately 40-50 feet away).

Once you are confident that the system is working, reset the Transmitter controls to the original setting.

Terms of Use and Limitation of Liability

1. Terms of Use

This Product is offered to you conditioned upon your acceptance without modification of the terms, conditions and notices contained herein. Usage of this Product implies acceptance of all such terms, conditions, and notices.

2. Proper Use

This Product is designed for use with pets where training is desired. The specific temperament of your pet may not work with this Product. If you are unsure whether this is appropriate for your pet, please consult your veterinarian or certified trainer.

3. No Unlawful or Prohibited Use

This Product is designed for use with pets only. This pet training device is not intended to harm, injure or provoke. Using this Product in a way that is not intended could result in violation of Federal, State or local laws.

4. Limitation of Liability

In no event shall Radio Systems® Corporation be liable for any direct, indirect, punitive, incidental, special or consequential damages, or any damages whatsoever arising out of or connected with the use or misuse of this Product. Buyer assumes all risks and liability from the use of this Product.

5. Modification of Terms and Conditions

Radio Systems® Corporation reserves the right to change the terms, conditions and notices under which this Product is offered.

Compliance

USA/Canada

This equipment has been tested and found to comply with the limits for a Class B digital device, pursuant to Part 15 of the FCC Rules. These limits are designed to provide reasonable protection against harmful interference when the equipment is operated in a residential environment. This equipment generates, uses, and can radiate radio frequency energy and, if not installed and used in accordance with the instruction guide, may cause harmful interference to radio communications. However, there is no guarantee that interference will not occur in a practical installation. If this equipment causes harmful interference to radio or television reception, which can be determined by turning the equipment off and on, the user is encouraged to try to correct the interference by one or more of the following measures:

- Relocate the interfered receiving antenna.
- Increase the separation between the equipment and receiver.
- Connect the equipment into an outlet on a circuit different from that to which the receiver is connected.
- Contact the Customer Care Center at 1-800-732-2677.

This device complies with part 15 of the FCC Rules. Operation is subject to the following two conditions: (1) This device may not cause harmful interference, and (2) this device must accept any interference received, including interference that may cause undesired operation.

This device complies with Industry Canada licence-exempt RSS standard(s). Operation is subject to the following two conditions: (1) this device may not cause interference, and (2) this device must accept any interference, including interference that may cause undesired operation of the device.

Unauthorized changes or modifications to the equipment, not approved by Radio Systems® Corporation, could result in not meeting compliance with FCC or IC regulations and void the user's authority to operate the equipment.

Australia

This device complies with the applicable EMC requirements specified by the ACMA (Australian Communications and Media Authority).

Customer Care International

USA & Canada - Tel: 800-732-2677

Monday - Friday 8 AM - 8 PM / Saturday 9 AM – 5 PM

Australia - Tel: 1800 786 608

Monday - Friday 7:30 AM - 5 PM

New Zealand - Tel: 0800 543 054

Monday - Friday 10:30 AM - 7 PM

This product has the benefit of a limited manufacturer's warranty. Details of the warranty applicable to this product and its terms can be found at www.petsafe.net and/or are available by sending a stamped addressed envelope to PetSafe® Ltd. Redthorn House, Unit 9, Chorley West Business Park, Ackhurst Road, Chorley, Lancashire PR7 1NL, United Kingdom.

Perchlorate Battery

Perchlorate Material – special handling may apply. See www.dtsc.ca.gov/hazardouswaste/perchlorate.



Mounting Template

171 mm (6.75 Inches)



Radio Systems® Corporation
10427 PetSafe Way
Knoxville, TN 37932
1-800-732-2677
www.petsafe.net
Protected by US Patents 6,879,300;
6,921,089; 7,142,167 and D515,027.

400-1422

©2006 Radio Systems Corporation