

CATÁLOGO
DE PRODUTOS

ERGOMAIS
SOLUÇÕES ERGONÔMICAS

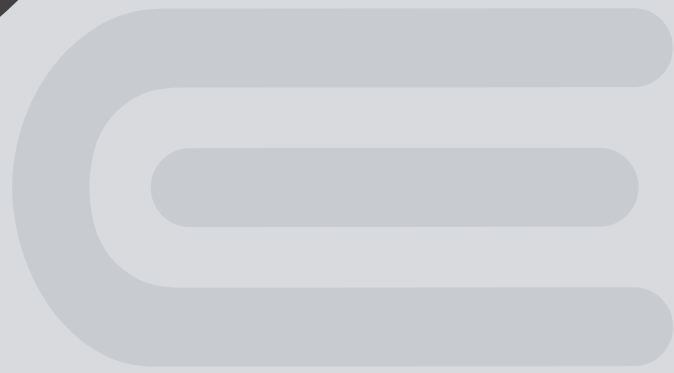

ERGONOMIA COM QUALIDADE

Com uma longa trajetória, de incontáveis experiências e desafios, a Ergomais se posiciona como uma indústria sólida com compromisso e seriedade, oferecendo soluções eficientes em Ergonomia de produtos para diversos setores da indústria e escritório, em todo território nacional e nos países da América Latina.

A Ergomais possui uma equipe técnica especializada em desenvolver produtos de acordo com as necessidades de diferentes ambientes de trabalho atendendo a todos os critérios exigidos pela NR17-Ergonomia do Ministério do Trabalho.

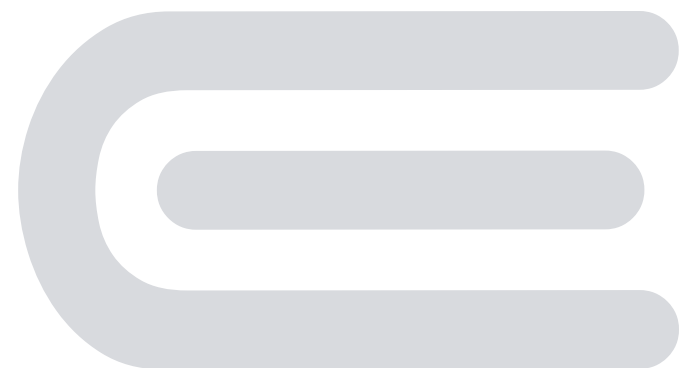

CADEIRAS ESCRITÓRIO



Desenvolvida para ambientes de escritório, nossas cadeiras são fabricadas com espuma de alta qualidade para assegurar o máximo conforto, as bordas são arredondadas para que não haja compressão da corrente sanguínea, Encosto e Assento possuem ajustes e regulagens para se adequar ao biótipo do usuário, a base e os rodízios facilita o deslocamento e ajuste de posição



KG
120kg
Capacidade

580mm
Altura máxima

450mm
Altura mínima

CADEIRAS
ESCRITÓRIO



STYLUS
PRESIDENTE

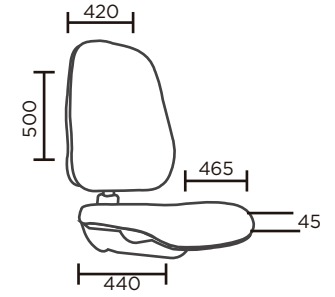

STYLUS
ALTA

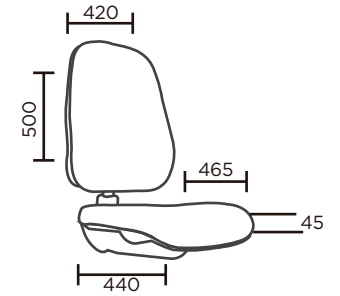

STYLUS
MÉDIA

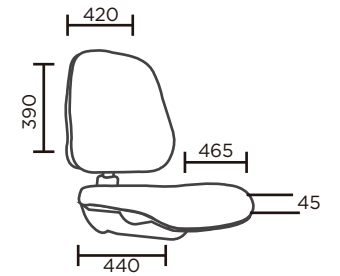

STYLUS
BAIXA

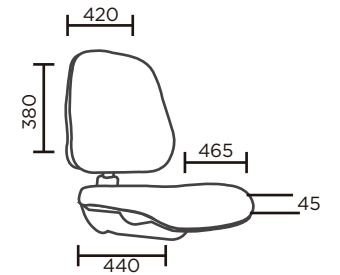

CADEIRAS
ESCRITÓRIO



STYLUS
MESH

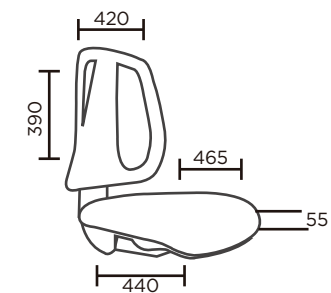

SYNK

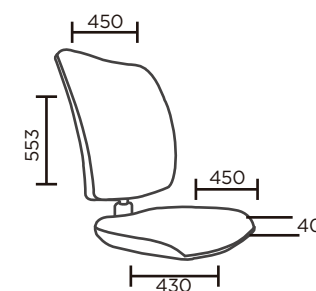

STANDART

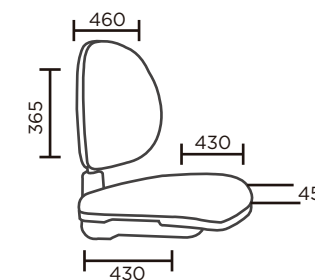

FRI

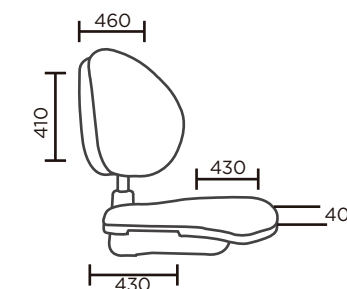

CADEIRAS
ESCRITÓRIO



ADDIT

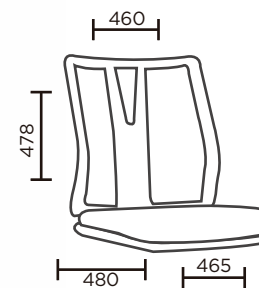

AGILE

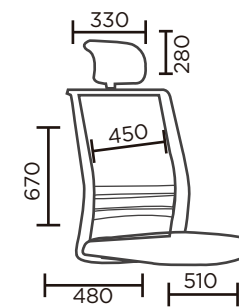

SOUL

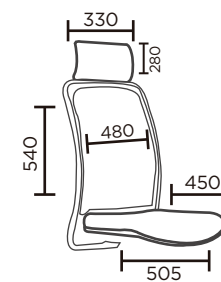

LISS

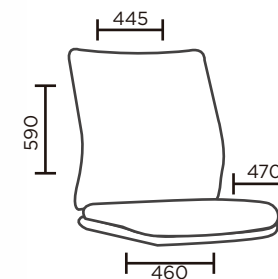

CADEIRAS
ESCRITÓRIO



DIRETOR

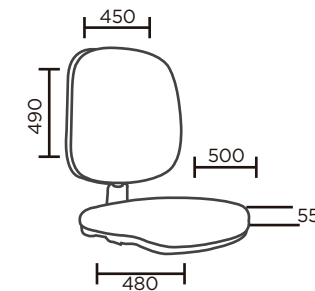

MAXXI
PESO
SUPPORTADO
180KG

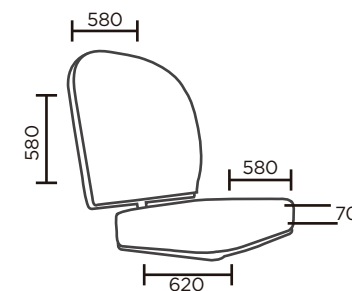

NEW

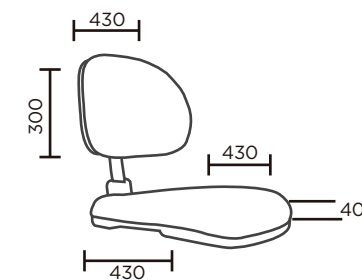

BASIC

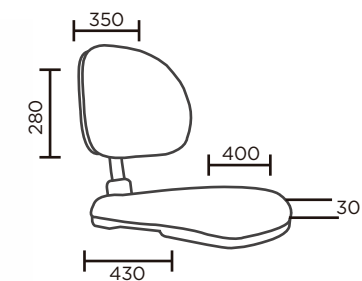

MESAS
REGULÁVEIS



BAIA
CALL CENTER

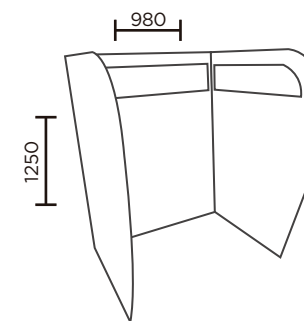

MESA
CALL CENTER

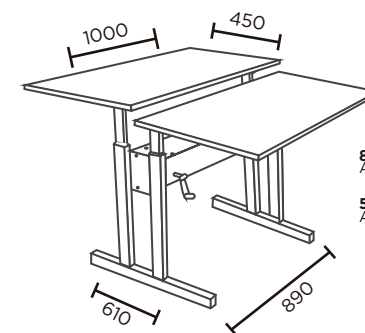

865
Altura máx
575
Altura mín



MESA L
COM
REGULAGEM
ELÉTRICA

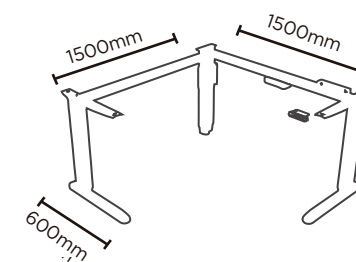

1140
Altura máx
730
Altura mín



MESA RETA
COM
REGULAGEM
ELÉTRICA

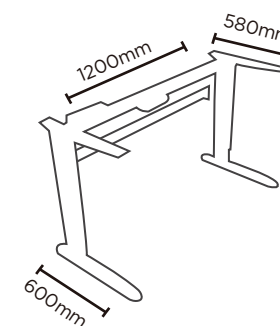

1140
Altura máx
730
Altura mín

APOIOS E SUPORTES

Nossos Apoios e suportes, são produzidos com materiais de alta qualidade e resistência, possuem regulagens que possibilita o ajuste correto por parte do usuário, contribuem para aliviar as tensões e compressões muscular, aumentando assim o conforto e a produtividade.



APOIO DE PÉS



SUPORTES DE MONITOR

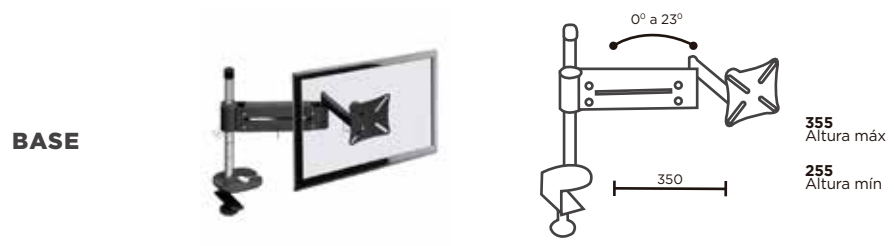

SUPORTES DE NOTEBOOK

ECONÔMICO
COM PORTA
CELULAR E
CANETA



REGULÁVEL



BANDEJA



**APOIO DE
PUNHO
COM MANTA**



**APOIO DE
PUNHO
SEM MANTA**



**APOIO DE
PUNHO
COM MANTA**



**APOIO DE
PUNHO
COM MANTA**



AAPOIO DE
PUNHO

**MOUSEPAD
QUADRADO**



**MOUSEPAD
QUADRADO
COM LOGO**



**MOUSEPAD
REDONDO
COM LOGO**



CADEIRAS INDUSTRIAIS



As cadeiras Industriais são desenvolvidas com matéria prima de excelente qualidade para atender ambientes com alta produtividade e diversos biótipos de pessoas, priorizando o conforto, possuem reforço em sua estrutura de base e de encosto, possuem todas as regulagens que exige a NR-17-Ergonomia, além de oferecer vários tipos de revestimento e alturas específicas atendendo as características particulares da maioria da industriais no setor de produção, laboratórios, vigilantes.



KG
120kg
Capacidade

870mm
Altura máxima

610mm
Altura mínima

CADEIRAS
INDUSTRIAIS



STYLUS
ALTA

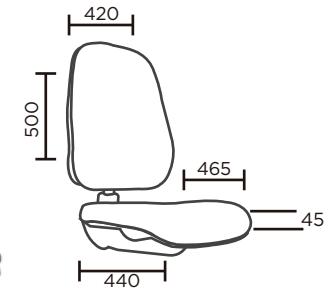

STYLUS
MÉDIA

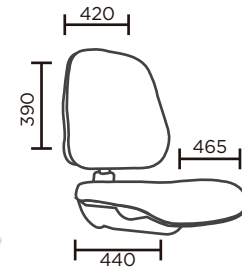

STANDART

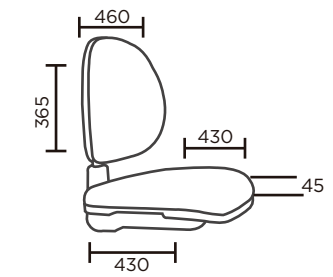

NEW

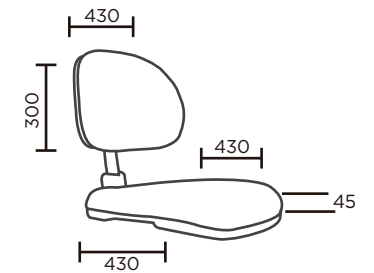

CADEIRAS
INDUSTRIAIS



BASIC

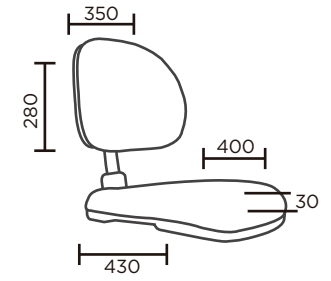

**P.U
POLIURETANO**

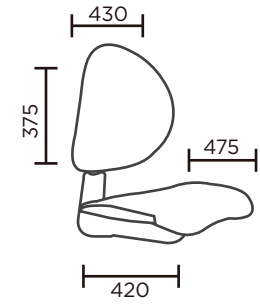

**P.U
ECONÔMICA**

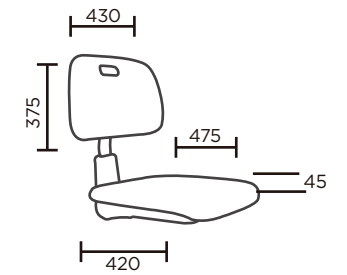

**P.P
POLIPROPILENO**

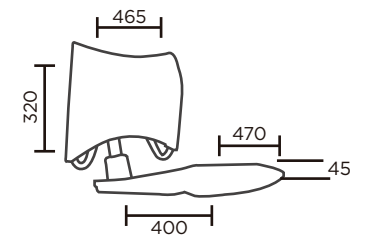

CADEIRAS
INDUSTRIAIS



**EXTRA
BAIXA**

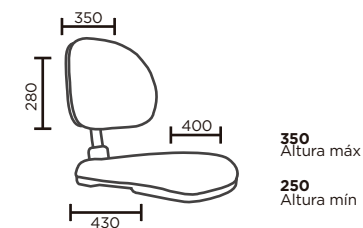

CHAPEADOR

Ideal para trabalho deitado em equipamentos suspensos.

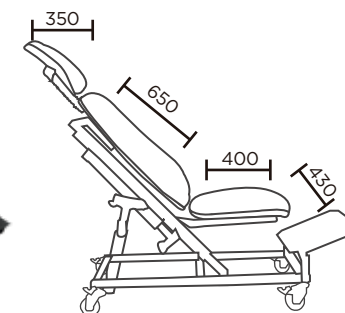

MANUTENÇÃO

Prioriza a posição deitada em equipamentos baixos próximos ao chão.

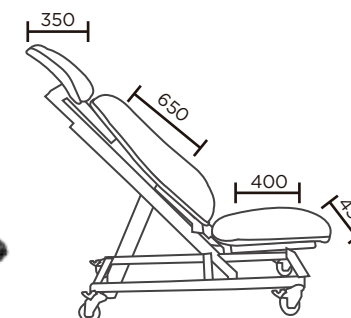

BANCO SEMI SENTADO

O Uso dos bancos Semi Sentado é importante, para alternar a postura entre em pé e sentado, o trabalho em pé por longos períodos aumenta o risco de lesões principalmente em membros inferiores. Nossos bancos são fabricados com alta qualidade, e se adaptam a vários ambientes de trabalho e ajustes para se adequar ao biótipo dos usuários oferecendo segurança e conforto. São utilizados em postos de trabalhos dinâmicos, que necessitam de movimentação constante ou não é possível utilizar cadeira.



BANCO
SEMI SENTADO



BANCO
EM AÇO
COM E SEM
ENCOSTO

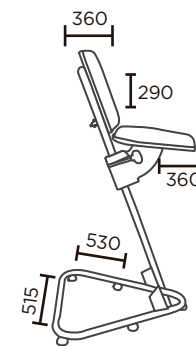

BANCO
À GÁS
COM E SEM
ENCOSTO

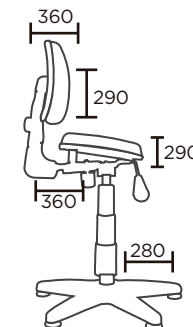

BANCO
COM
INCLINAÇÃO

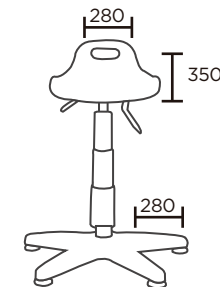

SELA

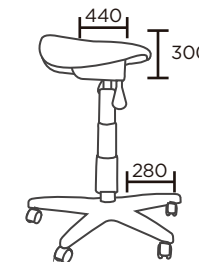

BANCADAS, TAPETES E CINTOS

As bancadas, os tapetes e cintos Ergomais são produtos complementares para projetos de melhorias Ergonômicas, oferecendo ajustes e conforto, diminuindo o esforço muscular, aumentando a produtividade, tornando o ambiente mais ergonômico.



BANCADAS
INDUSTRIAIS



HIDRÁULICA
COM REG.
DE ALTURA

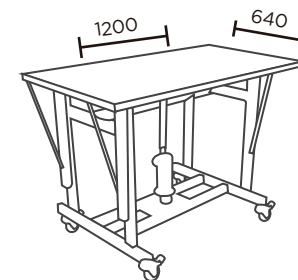

1030
Altura máx
900
Altura mín



ELÉTRICA
COM REG.
DE ALTURA

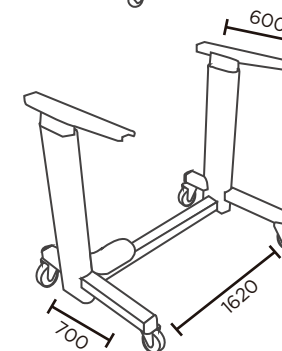

1140
Altura máx
730
Altura mín

TAPETES
ANTIFADIGA



BORMAIS
COM E SEM
ENCAIXE

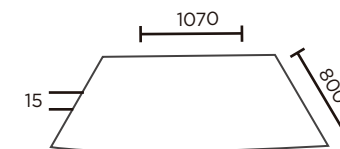

BUBBLE
COM E SEM
ENCAIXE

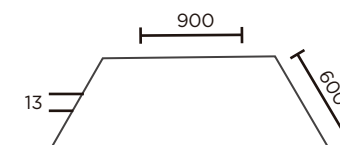
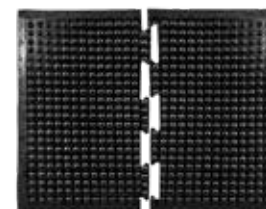

CINTO LOMBAR
ABDOMINAL**SUPERMAIS**

Fabricado em Tecido resistente 100% Lonita, com barbatanas internas em P.P. flexível, almofada de borracha EVA embutida. Com ou sem bolso.

**FLEXMAIS**

Fabricado em tecido 100% LYCRA, com barbatanas internas de nylon flexível.

**LIGHT**

Fabricado 100% em elástico de 100mm de largura, com 4 barbatanas plásticas.



Quadril

TABELA DE MEDIDAS

MANEQUIM	PP	P		M	G		GG	3G		4G
	36	38	40	42	44	46	50	52	54	56
QUADRIL (cm)	84	88	96	100	104	108	116	120	124	130

POSTOS DE TRABALHOS ESPECÍFICOS

A Ergomais oferece soluções inovadoras em produtos ergonômicos corporativos líderes de mercado alinhando a ergonomia, funcionalidade e conforto, atendendo os mais diversos segmentos como: Indústria Frigorífica, Alimentícia, Farmacêutica, eletroeletrônica, Confeção, Supermercados e Call Centers.





ESCRITÓRIO
LINHAS



STYLUS ALTA



STYLUS MÉDIA



STYLUS BAIXA



STANDART

INDUSTRIAL
LINHAS



STYLUS ALTA



STYLUS MÉDIA



STYLUS BAIXA



STANDART

BANCOS
SEMI SENTADO
ESD



EM AÇO



EM AÇO



À GÁS



À GÁS

CADEIRAS
CONFEÇÃO



STYLUS
MÉDIA

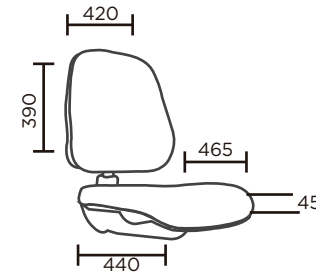

680
Altura máx
450
Altura mín



STYLUS
BAIXA

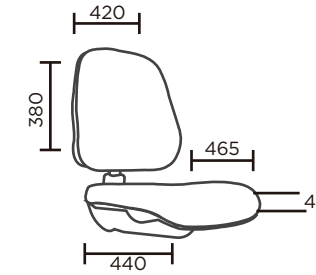

680
Altura máx
450
Altura mín

CADEIRAS
SUPERMERCADO



STANDART

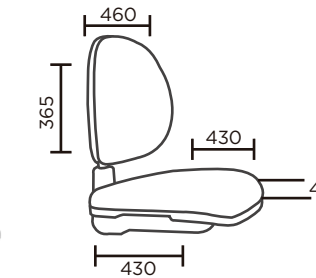

780
Altura máx
650
Altura mín



NEW

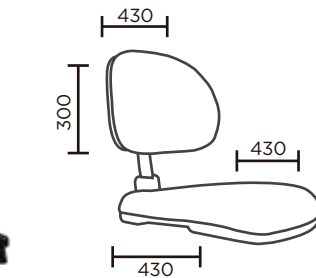

780
Altura máx
650
Altura mín

INOX
PARA INDÚSTRIAS FRIGORÍFICAS,
FARMACÊUTICAS E ALIMENTÍCIA



CADEIRA
INOX

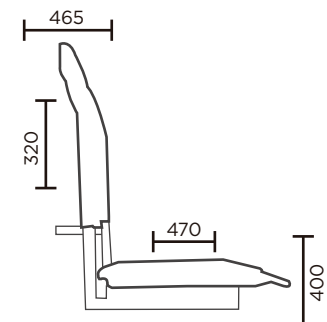

BANCO
SEMI SENTADO
INOX

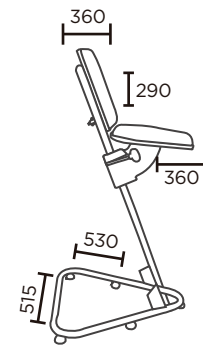

APOIOS
DE PÉS
INOX

3 ALTURAS



8 ALTURAS



14 ALTURAS



ARO ACOPLADO

ALTURA DAS CADEIRAS



ALTURA MÁX:
350mm

ALTURA MIN:
250mm

CADEIRA EXTRA BAIXA

Indicada para:
Pega: entre 500 a 600 mm
Posto de trabalho de 450 a 500 mm.



ALTURA MÁX:
450mm

ALTURA MIN:
350mm

CADEIRA BAIXA

Indicada para:
Pega: entre 600 a 700 mm
Posto de trabalho de 500 a 600 mm.



ALTURA MÁX:
580mm

ALTURA MIN:
450mm

CADEIRA SECRETÁRIA

Indicada para:
Posto de trabalho de 700 a 750 mm.



ALTURA MÁX:
680mm

ALTURA MIN:
560mm

CADEIRA COM PROLONGADOR

Indicada para:
Posto de trabalho de 800 a 850 mm.



ALTURA MÁX:
870mm

ALTURA MIN:
610mm

CADEIRA INDUSTRIAL

Indicada para:
Pega: entre 500 a 600 mm
Posto de trabalho de 850 a 950 mm.

TIPOS DE REVESTIMENTOS

TECIDO



É indicado para locais climatizados como escritórios e indústrias, onde não há sujidades como óleos, graxas ou muita poeira. Os tipos de tecido mais comuns são Panamá, J Serrano, e Crepe.



COURVIN

É impermeável, de fácil higienização e limpeza. Indicado para locais onde a higienização seja constantes, não absorve suor ou sujeira do ambiente. Pouco resistente a materiais cortantes e a batidas.



RASPA DE COURO

É resistente a fagulhas de soldas incandescentes, não propaga chama. É indicado para revestir cadeiras e bancos que ficam em áreas de soldas ou que podem ser atingidas por fagulhas.



ESD

Tecido composto por filamentos de carbono, que dissipam a eletricidade estática do corpo. Pode ser aplicada no tecido ou no corvin, conferem em cadeiras e bancos.



P.U POLIURETANO

Injetado em poliuretano com acabamento integral Skin na mesma peça, dispensa uso de revestimentos, alta durabilidade e limpeza não solta fuligens. É indicado para locais onde a higienização é necessária e controlada.



P.P POLIPROPILENO

Injetado em PP Polipropileno com várias opções de cores, dispensa uso de revestimentos, alta durabilidade e limpeza não solta fuligens. É indicado para locais onde a higienização é necessária e controlada.



ERGONOMIA
SAÚDE E
QUALIDADE,
EM TODOS
OS LUGARES.



*Diversas linhas ergonômicas para a indústria e escritório.

ERGOMAIS

SOLUÇÕES ERGONÔMICAS



www.ergomais.com.br



(12) 3955-4100



(12) 3955-4110 (Estado de SP)



(12) 3955-4113 (Demais localidades)